

Naturally Naturals

Quilt by Jean Ann Wright

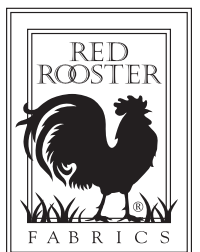

Finished quilt size: 60" x 60"



FABRIC REQUIREMENTS:

Pattern #16934 – WHII	1/4 yard
16935 – WHII	1/4 yard
16938 – WHII	1/4 yard
16939 – WHII	1/4 yard
16940 – WHII	1/4 yard
16941 – WHII	1/4 yard
16934 – CRE1	1/8 yard
16935 – CRE1	1/8 yard
16936 – CRE1	1/8 yard
16938 – CRE1	1/8 yard
16939 – CRE1	1/8 yard
16940 – CRE1	3/8 yard
16941 – CRE1	1/8 yard
16934 – BEII	2/3 yard
16935 – BEII	1/3 yard
16936 – LTBEII	1/4 yard
16936 – BEII	1 yard
16938 – BEII	1/3 yard
16939 – BEII	1/3 yard
16940 – BEII	1 1/8 yards
16941 – BEII	1/3 yard
	(includes binding)
Backing	3 3/4 yards
Batting	66" x 66"

ADDITIONAL SUPPLIES:

- Fusible web for appliqué
- Khaki machine embroidery thread for appliqué

CUTTING INSTRUCTIONS:

Cut fabrics in order given.

A. Pattern #16934 – WHII (floral):

1. Cut three 2 1/2" x 42" strips (A).

B. Pattern #16935 – WHII (stripe):

1. Cut three 2 1/2" x 42" strips (B).

C. Pattern #16938 – WHII (petite floral):

1. Cut three 2 1/2" x 42" strips (C).

D. Pattern #16939 – WHII (poppy):

1. Cut three 2 1/2" x 42" strips (D).

E. Pattern #16940 – WHII (string & dots):

1. Cut two 2 1/2" x 42" strips (E).

F. Pattern #16941 – WHII (mandolin):

1. Cut two 2 1/2" x 42" strips (F).

G. Pattern #16934 – CRE1 (floral):

1. Cut one 3 7/8" x 42" strip. Recut into eight 3 7/8" squares, then cut on the diagonal once to make sixteen triangles (G).

H. Pattern #16935 – CRE1 (stripe):

1. Cut one 3 7/8" x 42" strip. Recut into eight 3 7/8" squares then cut on the diagonal once to make sixteen triangles (H).

I. Pattern #16936 – CRE1 (small dot):

1. Cut one 3 7/8" x 42" strip. Recut into eight 3 7/8" squares then cut on the diagonal once to make sixteen triangles (I).

J. Pattern #16938 – CRE1 (petite floral):

1. Cut one 3 7/8" x 42" strip. Recut into eight 3 7/8" squares then cut on the diagonal once to make sixteen triangles (J).

K. Pattern #16939 – CRE1 (poppy):

1. Cut one 3 7/8" x 42" strip. Recut into eight 3 7/8" squares, then cut on the diagonal once to make sixteen triangles (K).

L. Pattern #16940 – CRE1 (string & dots):

1. Cut one 6 1/2" x 42" strip. Recut into four 6 1/2" squares (L).
2. Cut one 4 1/2" x 42" strip. Recut into four 4 1/2" x 6 1/2" rectangles (L2).

M. Pattern #16941 – CRE1 (mandolin):

1. Cut one 3 7/8" x 42" strip. Recut into eight 3 7/8" squares then cut on the diagonal once to make sixteen triangles (M).

N. Pattern #16934 – BEII (floral):

1. Cut one large center flower, four corner flowers and four buds from appliqué templates.*
2. Cut four corner round flowers from appliqué templates for border corners.*

O. Pattern #16935 – BEII (stripe):

1. Cut one 8 1/2" x 42" strip. Using template, cut ten wedge border pieces (U).

P. Pattern #16936 – LTBEII (small dot):

1. Cut one 8 1/2" x 42" strip. Using template, cut ten wedge border pieces (U).

Q. Pattern #16936 – BEII (small dot):

1. Cut three 7 1/4" x 42" strips. Recut into twelve 7 1/4" squares, then cut on the diagonal twice to yield four triangles from each square for a total of forty-eight triangles (Q).
2. Cut one 8 1/2" x 42" strip. Using template, cut ten wedge border pieces (U).

R. Pattern #16938 – BEII (petite floral):

1. Cut one 8 1/2" x 42" strip. Using template, cut ten wedge border pieces (U).

S. Pattern #16939 – BEII (poppy):

1. Cut one 8 1/2" x 42" strip. Using template, cut ten wedge border pieces (U).

T. Pattern #16940 – BEII (string & dots):

1. Cut seven 2 1/2" x 42" strips. Sew together end-to-end, then recut two 24 1/2" vertical borders (T1), two 28 1/2" horizontal borders (T2), two 40 1/2" vertical borders (T3), and two 44 1/2" horizontal borders (T4).
2. Cut seven 2 1/2" x 42" strips for binding.

U. Pattern #16941 – BEII (mandolin):

1. Cut one 8 1/2" x 42" strip. Using template, cut ten wedge border pieces (U).

* Following the manufacturer's directions, trace the appliqué templates on the fusible web and fuse to fabric before cutting.

PIECING INSTRUCTIONS: Use 1/4" seam allowances.

1. Center appliqué block: Make a strip set by sewing one each of strips A, B, C, D, E and F together to make a 12 1/2" wide unit. Make two. Recut a total of four 12 1/2" squares.
2. Make one strip set from the remaining A, B, C, and D strips. Recut into four 8 1/2" squares for outer border corners.
3. Sew the four 12 1/2" strip pieced squares into a large square, alternating the direction of the strips. Following the manufacturer's directions for the fusible web, fuse the appliqué pieces in place for the center flower design. Using the khaki embroidery thread and a satin stitch, sew the appliqué pieces to the background square. [Tip: experiment with your satin stitch on fabric scraps to set your stitch length and width before sewing the center square]. Center block finished size: 24" square.
3. Appliqué the four border corner blocks in the same manner as the center block. Make four. Set the border blocks aside.
4. Sew a T1 strip to opposite sides of the center square, then sew a T2 strip to the top and bottom of the center square.
5. Using the small G, H, I, J, K and M triangles and the fabric Q triangles, sew together forty-eight flying geese units using matching small triangles in each unit. Press the units using a fabric sizing or spray starch to stabilize. Trim each of the units to measure 2 1/2" x 6 1/2", trimming on the Q side of the unit (Figure 1).

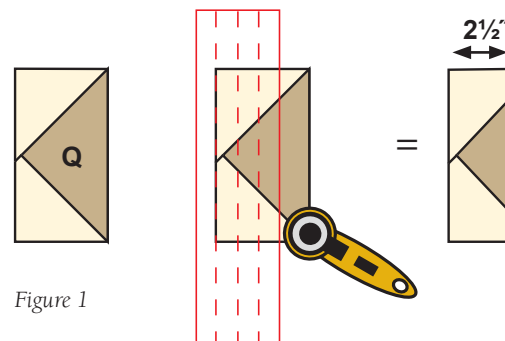

Figure 1

6. Sew the trimmed flying geese units into eight strips with six units each. Sew one of these units to each side of an L2 rectangle, with the points of the geese facing away from the center, to make four border strips. Sew one of the border strips to each side of the center square.
7. Sew a fabric L square to each end of the two remaining flying geese border strips. Sew the borders to the top and bottom of the center square.
8. Sew a T3 strip to opposite sides of the center square, then sew a T4 strip to the top and bottom of the center square.
9. Sew fifteen wedge pieces together giving every other piece a half turn to make a border strip. Make four borders. Fold the border strip in half

and press the center fold line. Keeping the border folded, measure 22¼" from the center fold line and trim the edges at a right angle to straighten the border ends. Trim all four borders.

10. Sew a border strip to opposite sides of the quilt top. Sew a reserved appliquéd border corner block to each end of the two remaining border strips. Sew to the top and bottom of the quilt.

FINISHING:

1. Prepare backing to measure 66" square.
2. Layer the quilt top, batting, and backing. Baste layers together.
3. Quilt as desired.
4. Trim the backing and batting even with the quilt top.
5. Join the binding strips with diagonal seams. Press seams open. Attach binding to quilt using your favorite method.

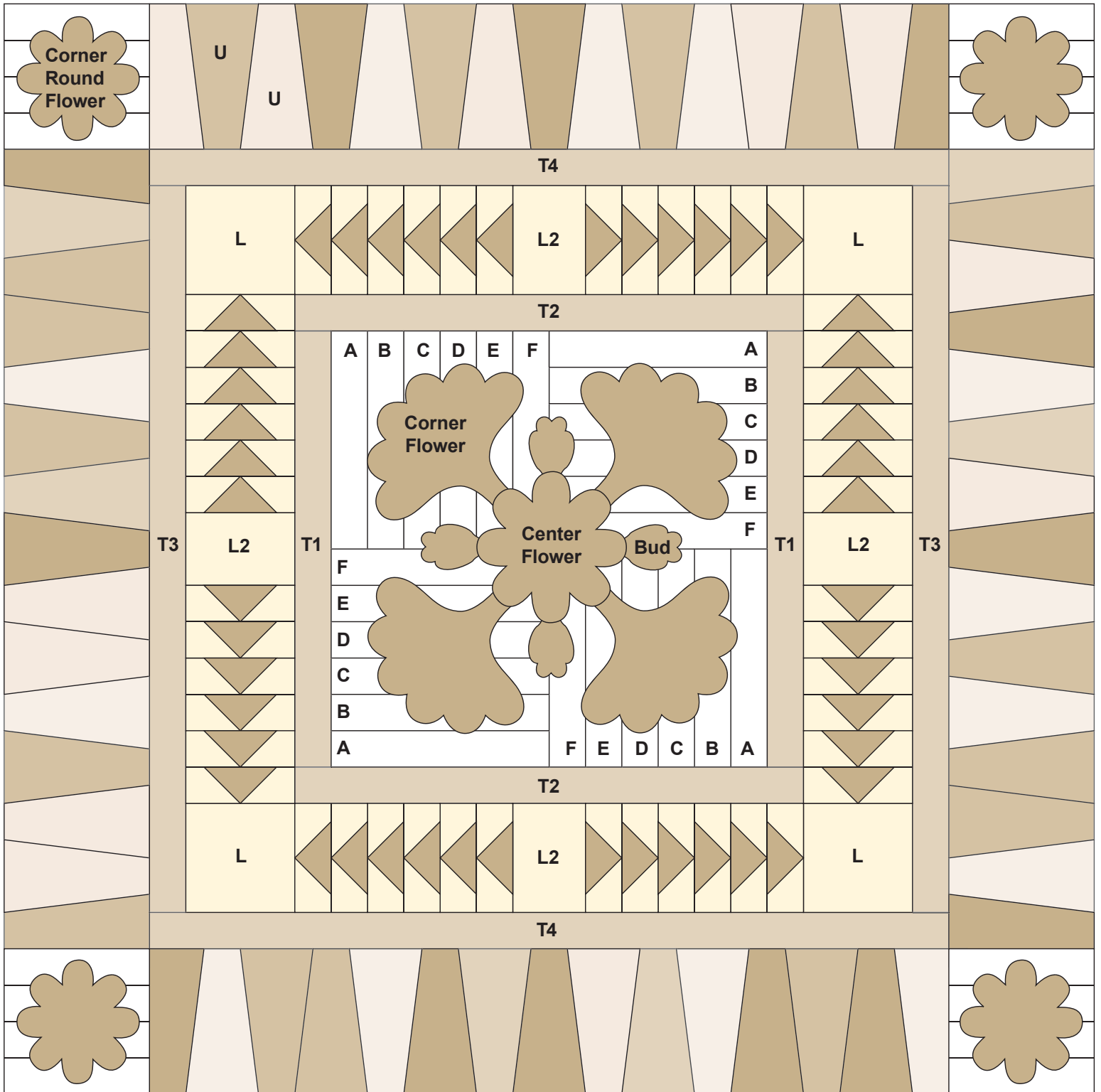

Quilt Diagram

Templates at 100%

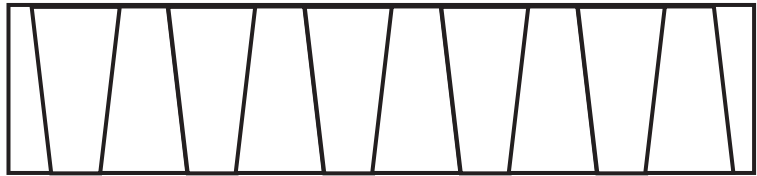

Cutting Layout Diagram

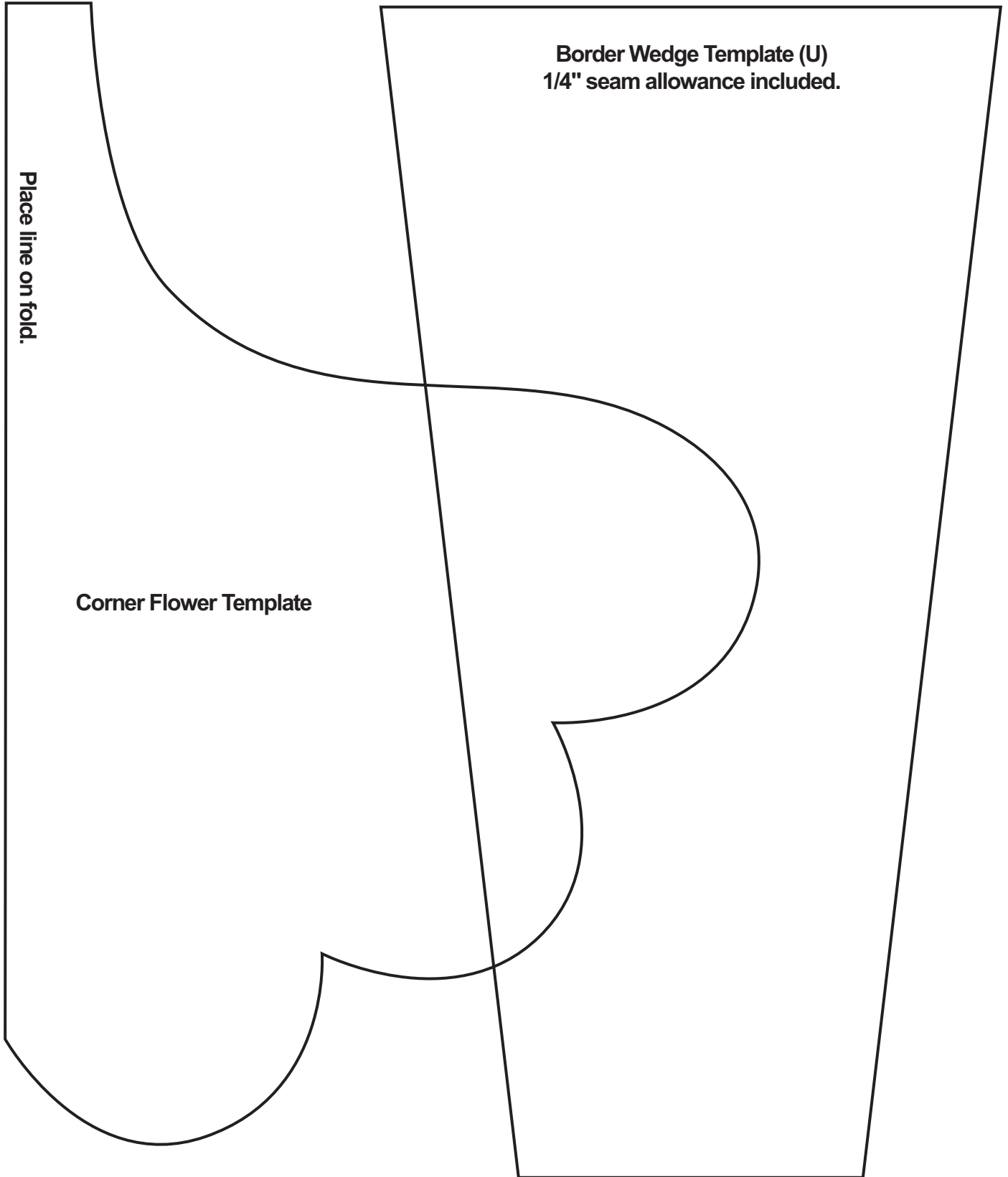

Place line on fold.

Corner Flower Template

Border Wedge Template (U)
1/4" seam allowance included.

Templates at 100%

Center
Flower
Template

Corner
Round
Flower
Template

Bud
Template

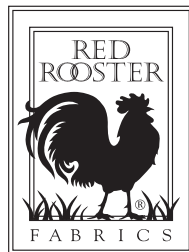

Scale Check for pdf files
When you print these templates, this ruler should measure 2 inches long. If it does not, change, "page scaling" to "none" in the print dialog box.

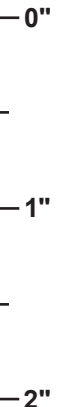

©2008 Red Rooster Fabrics. All rights reserved. Not intended for individual resale.

The design for this Red Rooster Fabrics' pattern is protected by U.S. copyright law.
For additional copies of this pattern please call or write Red Rooster Fabrics at the address listed below.
253 West 35th Street, 11th Floor, New York, NY 10001 • 401.728.4200 • www.redroosterfabrics.com

We take great care to ensure that the information included in our free pattern is accurate and presented in good faith. No warranty is provided nor results guaranteed. For your convenience, we post an up-to-date listing of corrections on our website: <http://www.redroosterfabrics.com/quilt/loops.php>
If a correction is not noted, please contact our customer service department at info@redroosterfabrics.com. You may also call or write us at the address above.